

Services and Solutions for Global Energy and Electro-Mechanical Industries



Design, Engineering, Manufacturing, Commissioning Expertise

Bachmann Industries is an established market leader for the design and supply of products and solutions for energy segment. With a long standing for over 30 years, we are pioneers in products, solutions and services for the energy value chain ranging from oil production to retail and power generation and other electro-mechanical industries. Bachmann has in-house capabilities for Design, Engineering and Manufacturing to execute turnkey projects from Concept to Commissioning.

World-class Quality

Bachmann uses cutting-edge technology from its tie-ups with leading engineering companies in the USA, Singapore and Australia. Our facilities use state-of-the-art infrastructure and our operations are certified to ISO 9001 standards.

Service and Support - Customer First

Bachmann assist customers in completing their projects faster by shrinking design to implementation time using its integrated infrastructure. We provide world-class quality meeting customer's expectations and endeavor in continuous customer satisfaction and is evident from our repeated customers.



Systems & Packages

Bachmann India was established in 1987 as an Indo-American JV with Wahlco -Metroflex Inc, USA (now part of the Senior Plc group) - a leader in the design and supply of packages for flue gas control systems. In association with an Australian company (now part of Downer Engineering) we undertake turnkey supply of Gas Turbine Inlet & Exhaust Systems indigenized for the domestic & international market. From our partners - NAP Acoustics SEA, Singapore, we have developed expertise in design and supply of Acoustic Noise Control Systems.



Over the years, **Bachmann** developed several systems and today we design & manufacture specialty systems and process packages for a wide range of applications in Oil & Gas, Power, Petrochemical, Mining & Metals, Utility and several other industrial requirements.

Bachmann systems are custom engineered for effective & efficient performance, delivering many years of reliable service for plant's smooth & safe operation. Depending on specific requirement, packages may be supplied as integrated units, or as individual components.

Our fully integrated infrastructure in a covered area of 150,000 ft² is equipped with latest manufacturing facilities and processes and certified to ISO 9001 standards. We employ about 300 professionals and provide services from Concept - Engineering - EPC - Manufacturing through Commissioning.



Design & Engineering Services

Bachmann from its Centers in India and UAE provides Design, Engineering, Consulting and Sourcing services to worldwide customers. **Bachmann** specializes in providing end-to-end engineering services to Oil & Gas, Power, Petrochemical, Mining & Metals, Utility and Electro-Mechanical industries.

Technology Developers	Engineering & EPC Companies	Equipment / System Manufactures	Owner/ Operators
Service Capability			
Product Development Support PFD, P&ID Development Manufacturing Support	FEED/Basic Engineering. Detail Design / Engineering Integrated 3D Engineering Analysis & Simulations	Equipment Design Detail Design, FEA & FEM 3D Modeling Fabrication Drawings	Feasibility Study Project Management Asset Management Site/ Engg validations

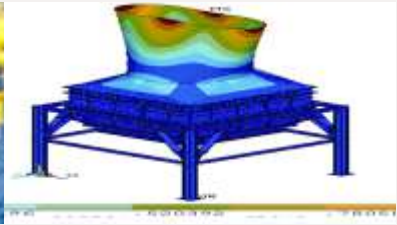
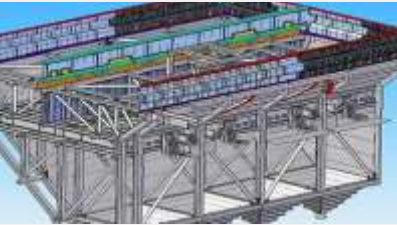

Bachmann combines Engineering, CAD & CAE applications and Technological tools (Product Design, Detailing, Modeling, Visualization, Analysis) for efficient and effective use on greenfield and brownfield projects to generate intelligent 3D plant models and 2D drawings and collaboration between 2D & 3D Digital data. **Bachmann** supports customers' requirements for plant revamping/ expansion, relocation, modification and retrofits and As-is/ As-built documentation and other brownfield requirements adopting 3D Laser Scanning for Data capture & Digital plant model.

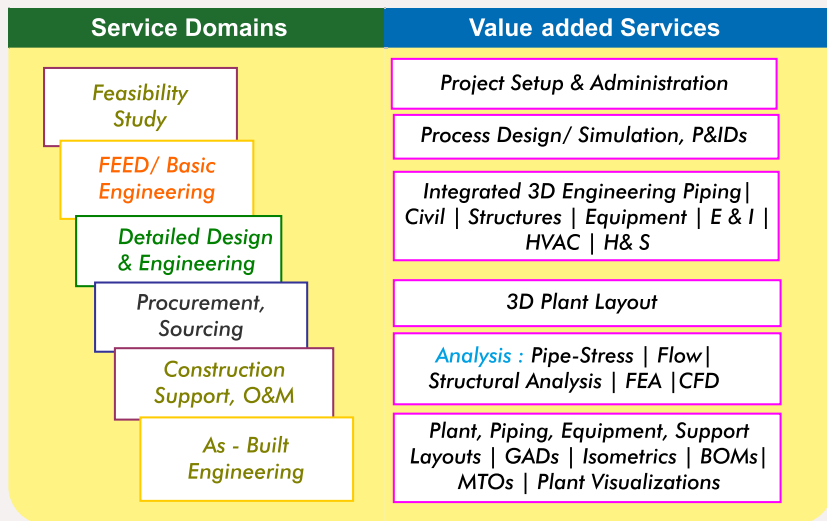

Highest quality comes from skilled engineers with strong domain and functional expertise. Our Engineering centers help to achieve significant project savings while achieving the desired quality.

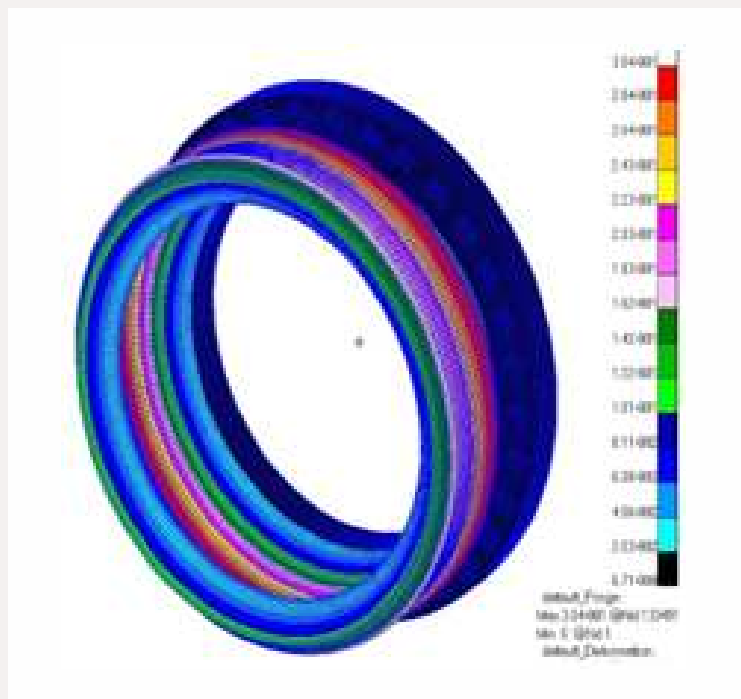

Products & Trading

Bachmann backed by decades of experience in providing Concept to Commissioning services, undertakes Project Management, Sourcing & Procurement Services for a variety of general items, Products, Equipment, Sub-systems, Systems and Packages. Having worked on global projects and locations, Bachmann team understands the entire value chain and helps customers in getting the right product & solution on optimized terms and conditions to help accelerate the project implementation.

We help in every stage of the project lifecycle from feasibility to O&M and act as an extended sourcing and supply team of our Customers.

The experience of worldwide export and import of materials with the additional services of expediting and vendor inspection for projects and on behalf of customers, provides added value while sourcing materials from a large network of qualified suppliers and vendors for Oil & Gas, Power and Utility Industries.

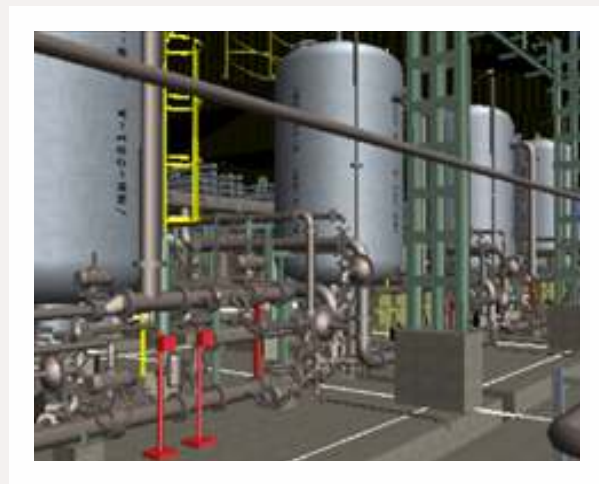

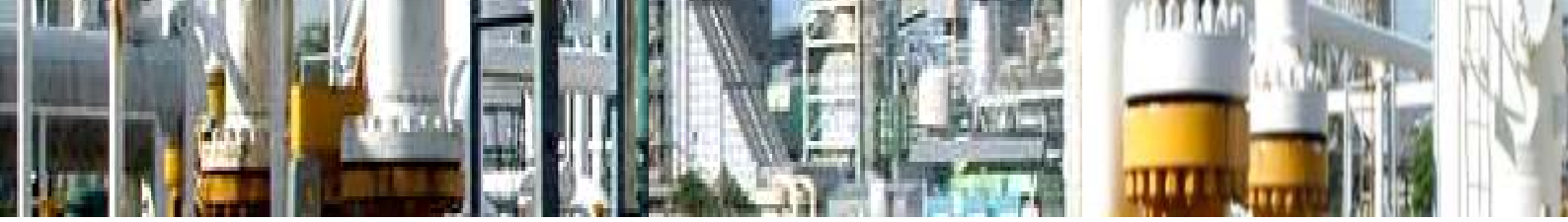

Some of the **Products** handled are:

- ❖ Acoustic Enclosures
- ❖ Asset Management Solutions
- ❖ Automation Tools
- ❖ Control Panels & Systems
- ❖ Cooling Towers
- ❖ Diffusers, Transitions, Equalisers
- ❖ DG Sets
- ❖ Electrical & Instrumentation items like Level Instruments, Flow Instruments, Pressure Instruments, Actuators, Cables, Cable trays, Switchgears, capacitor banks, UPS etc.
- ❖ Exhaust Stacks & Stack Dampers
- ❖ ETP/ STP/ WTPs
- ❖ Expansion Joints
- ❖ Flow Control Systems
- ❖ Glandular Spade / Goggle valves
- ❖ Heaters
- ❖ Launchers and Receivers
- ❖ Louvers
- ❖ Piping items like Pipes, Fitting, Flanges, Spring Hangers etc.
- ❖ Process equipment (Heat Exchangers, Columns, Pressure vessels, Reactors)
- ❖ Process packages/ skids
- ❖ Silencers and Ducting
- ❖ Software solutions & Services
- ❖ Spare parts for power, Mechanical and Instrumentation
- ❖ Sub-station solutions
- ❖ Tanks & Structures
- ❖ Valves - All types
- ❖ Wellhead Systems

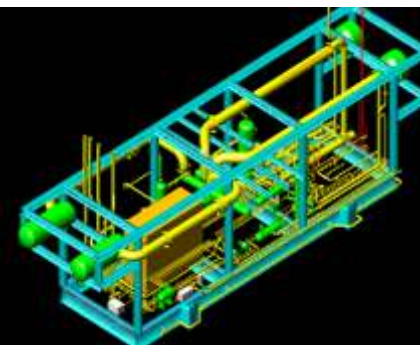

We have an enviable reference list of customers acquired over three decades of experience. These include leading companies in Oil & Gas, Power, Metal & Mining and Utilities, out of which to name a few are -Doosan, Babcock, IOCL, ONGC, Reliance, Siemens, Vale Oman, BHEL, Petronor etc.

For more information on our services, solutions & products contact us :

INDIA

Bachmann Industries India Limited
Plot No. 10, Sector 6, Faridabad, India -121006
E: sales@bachmannindia.com
T: +91-129-2241040, F: +91-129-2242126

UAE/ International
Bachmann Engineering
E: enq@bachmannindia.com
M: +971-528952338

www.bachmannindia.com